

Computing connected proof(-structure)s from their Taylor expansion

Giulio Guerrieri^{1,2}, Luc Pellissier³, and Lorenzo Tortora de Falco¹

- 1 Dipartimento di Matematica e Fisica, Università Roma Tre, Rome, Italy
- 2 Aix Marseille Université, CNRS, Centrale Marseille, I2M UMR 7373, F-13453, Marseille, France
- 3 LIPN, UMR 7030, Université Paris 13, Sorbonne Paris Cité
F-93430 Villetaneuse, France
luc.pellissier@lipn.univ-paris13.fr, {gguerrieri,tortora}@uniroma3.it

Abstract

We show that every connected Multiplicative Exponential Linear Logic (MELL) proof-structure (with or without cuts) is uniquely determined by a well-chosen element of its Taylor expansion: the one obtained by taking two copies of the content of each box. As a consequence, the relational model is injective with respect to connected MELL proof-structures.

1998 ACM Subject Classification F.4.1 Mathematical Logic

Keywords and phrases proof-nets, (differential) linear logic, relational model, Taylor expansion

Digital Object Identifier 10.4230/LIPIcs.FSCD.2016.<article-no>

1 Introduction

Given a syntax \mathcal{S} endowed with some rewrite rules, and given a denotational model \mathcal{D} for \mathcal{S} (*i.e.* a semantics which associates with every term t of \mathcal{S} an interpretation $\llbracket t \rrbracket_{\mathcal{D}}$ that is invariant under the rewrite rules), we say that \mathcal{D} is *injective* with respect to \mathcal{S} if, for any two normal terms t and t' of \mathcal{S} , $\llbracket t \rrbracket_{\mathcal{D}} = \llbracket t' \rrbracket_{\mathcal{D}}$ implies $t = t'$. In categorical terms, injectivity corresponds to faithfulness of the interpretation functor from \mathcal{S} to \mathcal{D} . Injectivity is a natural and well studied question for denotational models of λ -calculi and term rewriting systems (see [10, 18]). In the framework of Linear Logic (LL, [11]) this question, addressed in [19], turned out to be remarkably complex: contrary to what happens in the λ -calculus, there exist semantics of LL that are not injective, such as the coherent model which is injective only with respect to some fragments of LL (see [19]). After the first partial positive results obtained in [19], it took a long time to obtain some improvements: in [5], the injectivity of the relational model is proven for MELL (the multiplicative-exponential fragment of LL, sufficiently expressive to encode the λ -calculus) proof-structures that are connected, and eventually in [3] the first complete positive result is achieved, since the author proves that the relational model is injective for all MELL proof-structures.

Ehrhard [6] introduced finiteness spaces, a denotational model of LL (and λ -calculus) which interprets formulas by topological vector spaces and proofs by analytical functions: in this model the operations of differentiation and Taylor expansion make sense. Ehrhard and Regnier [7, 8, 9] internalized these operations in the syntax and thus introduced differential linear logic DiLL₀ (which encodes the resource λ -calculus, see [8]), where the promotion rule (the only one in LL which is responsible for introducing the !-modality and hence for creating resources available at will, marked by boxes in LL proof-structures) is replaced by three new “finitary” rules introducing the !-modality which are perfectly symmetric to the rules



© Giulio Guerrieri, Luc Pellissier and Lorenzo Tortora de Falco;
licensed under Creative Commons License CC-BY

1st International Conference on Formal Structures for Computation and Deduction (FSCD 2016).



Leibniz International Proceedings in Informatics

LIPICs Schloss Dagstuhl – Leibniz-Zentrum für Informatik, Dagstuhl Publishing, Germany

for the $?$ -modality: this allows a more subtle analysis of the resources consumption during the cut-elimination process. At the syntactic level, the Taylor expansion decomposes a LL proof-structure/ λ -term in a (generally infinite) formal sum of DiLL₀ proof-structures/resource λ -terms, each of which contains resources usable only a fixed number of times. Roughly speaking, each element of the Taylor expansion \mathcal{T}_R of a LL proof-structure/ λ -term R is a DiLL₀ proof-structure/resource λ -term obtained from R by replacing each box/argument B in R with n_B copies of its content (for some $n_B \in \mathbb{N}$), recursively.

In the light of the differential approach, it is clear (and well-known) that the resource λ -term of order 1 in the Taylor expansion of a λ -term (which is obtained by taking exactly one copy of the argument of each application) is enough to entirely determine the λ -term: if two λ -terms t_1 and t_2 have the same element of order 1 in their Taylor expansion, then $t_1 = t_2$. One can formulate the results of [5] and [3] by saying that, given two LL proof-structures R_1 and R_2 , if there exists an appropriate DiLL₀ proof-structure, whose order *depends on* R_1 and R_2 , which occurs in the Taylor expansions of both R_1 and R_2 , then $R_1 = R_2$. We prove, in the present paper, for connected MELL, a result which is very much in the style of the one just mentioned for the λ -calculus: if two connected MELL proof-structures R_1 and R_2 (with or without cuts) have the same element of order 2 in their Taylor expansions (which is obtained by taking exactly two copies of the content of each box), then $R_1 = R_2$ (*i.e.* the element of order 2 of the Taylor expansion of a connected MELL proof-structure is enough to entirely determine the proof-structure). Since it is known (see [12] for details) that the elements of the Taylor expansion of a LL proof-structure/ λ -term are essentially the elements of its interpretation in the relational model, we immediately obtain another proof of the injectivity of the relational model for connected MELL proof-structures.

It is widely acknowledged, in the LL community, that the subsystem of LL corresponding to the λ -calculus enjoys all the possible good properties, while many of them are lost in the general MELL fragment. Our result seems to suggest the following hierarchy:

1. full MELL, for which there does not seem to be a way to bound “a priori” the complexity of the element of the Taylor expansion allowing to distinguish two different proof-structures;
2. connected MELL (containing the λ -calculus) for which the element of order 2 of the Taylor expansion of a proof-structure is enough to entirely determine the proof-structure;
3. the λ -calculus, for which the element of order 1 of the Taylor expansion of a λ -term is enough to entirely determine the λ -term.

Outline After laying out precise definitions of proof-structure (§2) and Taylor expansion (§3), in §4 we show how a connected MELL proof-structure can be univocally computed by the point of order 2 of its Taylor expansion. Finally, in §5 we infer from this the injectivity of the relational model for connected MELL.

► **Notation.** We set $\mathcal{L}_{\text{MELL}} = \{1, \perp, \otimes, \wp, !, ?, ax, cut\}$. The set $\mathcal{F}_{\text{MELL}}$ of MELL *formulas* is generated by the grammar: $A, B, C ::= X \mid X^\perp \mid 1 \mid \perp \mid A \otimes B \mid A \wp B \mid !A \mid ?A$, where X ranges over an infinite set of propositional variables. The linear negation is involutive, *i.e.* $A^{\perp\perp} = A$, and defined via De Morgan laws $1^\perp = \perp$, $(A \otimes B)^\perp = A^\perp \wp B^\perp$ and $(!A)^\perp = ?A^\perp$.

Let \mathcal{A} be a set: $\mathcal{P}(\mathcal{A})$ is the power set of \mathcal{A} , $\bigcup \mathcal{A}$ is the union of \mathcal{A} , \mathcal{A}^* is the set of finite sequences over \mathcal{A} . If \mathcal{A} is ordered by \leq , for any $a \in \mathcal{A}$ we set $\downarrow_{\mathcal{A}} a = \{b \in \mathcal{A} \mid b \leq a\}$. The empty sequence is denoted by $()$. Given a finite sequence $a = (a_1, \dots, a_n)$ with $n \in \mathbb{N}$, we set $|a| = n$ and, if $n > 0$, $a^- = (a_1, \dots, a_{n-1})$; if moreover $b = (b_1, \dots, b_m)$, we set $a \cdot b = (a_1, \dots, a_n, b_1, \dots, b_m)$; if $n = 1$ (resp. $m = 1$), then $a_1 \cdot b$ (resp. $a \cdot b_1$) stands for $a \cdot b$. We write $a \sqsubseteq b$ if $a \cdot c = b$ for some finite sequence c . Let $f: \mathcal{A} \rightarrow \mathcal{B}$ be a partial function (without “partial”, a function is always total): $\text{dom}(f)$ and $\text{im}(f)$ are the domain and image of f ; the partial function $\bar{f}: \mathcal{P}(\mathcal{A}) \rightarrow \mathcal{P}(\mathcal{B})$ is defined by $\bar{f}(\mathcal{A}') = \{f(a) \mid a \in \mathcal{A}' \cap \text{dom}(f)\}$ for any $\mathcal{A}' \subseteq \mathcal{A}$.

2 A non-inductive syntax for proof structures

It is well-known that for LL proof-nets there is no “canonical” representation: every paper about them introduces its own syntax for proof-nets, and more generally for proof-structures,

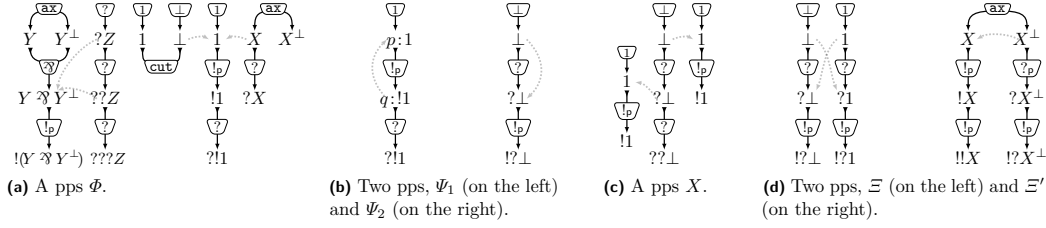

■ **Figure 1** Some examples of pps that are not DiLL-ps. See Def. 1 and 10.

depending on the purposes of the paper.¹ The first aim of the syntax for proof-structures that we present here is to give a rigorous and compact definition of the following notions: (1) equality between proof-structures; (2) Taylor expansion of a proof-structure. The first point naturally leads us to adopt a low-level syntax with generalized $?$ - and $!$ -links, similarly to [5]. This choice can be made compatible with the second point by giving a completely non-inductive definition of proof-structures, which is in keeping with the intuition that a proof-structure is a directed graph, plus further information about the borders of boxes. We have also taken care of minimizing the information required to identify a proof-structure, especially the borders of its boxes.

We use terminology of interactions nets [13, 8], even if properly speaking our objects are not interaction nets. So, for instance, our cells correspond to links in [2, 14, 19]. Our syntax is inspired by [15, 16, 17, 20, 4, 5]. The main technical novelties with respect to them are that:

- there are no wires (the same port may be auxiliary for some cell and principal for another cell), so axioms and cuts are cells, and our ports corresponds to edges in [2, 14, 19];
- boxes do not have an explicit constructor or cell, hence boxes and depth of a proof-structure are recovered in a non-inductive way.

As in [15, 16, 17] and unlike [4, 5], our syntactical objects are typed by MELL formulas: we have opted for a typed version only to keep out immediately the possibility of “vicious cycles” (see Fact 4). All the results in this paper can be adapted also to the untyped case.

Pre-proof-structures and isomorphisms We define here our basic syntactical object: *pre-proof-structure* (pps for short). All other syntactical objects, in particular proof-structures corresponding to the fragments or extensions of LL that we will consider (DiLL-, MELL- and DiLL₀-proof structures), are some special cases of pps. Essentially, a pps Φ is a directed labeled graph G_Φ called the *ground-structure* (gs for short) of Φ , plus a partial function box_Φ defined on certain edges (or nodes). The gs of Φ represents a “linearised” proof-structure, *i.e.* Φ without the border of its boxes; the partial function box_Φ marks the borders of the boxes of Φ . Examples of pps are in Fig. 1. Unlike [17, 5], our syntactical objects are not necessarily cut-free (nor with atomic axioms). Cut-elimination is not defined since it is not used here.

► **Definition 1** (Pre-proof-structure, ports, cells, ground-structure, fatness). A *pre-proof-structure* (pps for short) is a 9-tuple $\Phi = (\mathcal{P}_\Phi, \mathcal{C}_\Phi, \text{tc}_\Phi, \mathcal{P}_\Phi^{\text{pri}}, \mathcal{P}_\Phi^{\text{aux}}, \mathcal{P}_\Phi^{\text{left}}, \text{tp}_\Phi, \mathcal{C}_\Phi^{\text{box}}, \text{box}_\Phi)$ such that:

- \mathcal{P}_Φ and \mathcal{C}_Φ are finite sets, their elements are resp. the *ports* and the *cells* (or *links*) of Φ ;
- tc_Φ is a function from \mathcal{C}_Φ to $\mathcal{L}_{\text{MELL}}$; for every $l \in \mathcal{C}_\Phi$, $\text{tc}_\Phi(l)$ is the *label*, or *type*, of l ; for every $t, t' \in \mathcal{L}_{\text{MELL}}$, we set $\mathcal{C}_\Phi^t = \{l \in \mathcal{C}_\Phi \mid \text{tc}_\Phi(l) = t\}$ (whose elements are the t -cells, or t -links, of Φ) and $\mathcal{C}_\Phi^{t,t'} = \mathcal{C}_\Phi^t \cup \mathcal{C}_\Phi^{t'}$;

¹ Following [11], a proof-net is a proof-structure sequentializable (*i.e.* corresponding to a derivation) in LL sequent calculus: proof-nets can be (partly or completely, depending on the fragment of LL) characterized among proof-structures via “geometric” correctness criteria, see for instance [1, 19].

- $\mathbf{P}_{\Phi}^{\text{pri}}: \mathcal{C}_{\Phi} \rightarrow \mathcal{P}(\mathcal{P}_{\Phi})$ is a function such that $\bigcup \text{im}(\mathbf{P}_{\Phi}^{\text{pri}}) = \mathcal{P}_{\Phi}$ and moreover, for all $l, l' \in \mathcal{C}_{\Phi}$,
 - if $l \neq l'$ then $\mathbf{P}_{\Phi}^{\text{pri}}(l) \cap \mathbf{P}_{\Phi}^{\text{pri}}(l') = \emptyset$,
 - if $\text{tc}_{\Phi}(l) \in \{1, \perp, \otimes, \wp, !, ?\}$ then $\text{card}(\mathbf{P}_{\Phi}^{\text{pri}}(l)) = 1$,
 - if $\text{tc}_{\Phi}(l) = ax$ (resp. $\text{tc}_{\Phi}(l) = cut$) then $\text{card}(\mathbf{P}_{\Phi}^{\text{pri}}(l)) = 2$, (resp. $\text{card}(\mathbf{P}_{\Phi}^{\text{pri}}(l)) = 0$);
 for any $l \in \mathcal{C}_{\Phi}$, the elements of $\mathbf{P}_{\Phi}^{\text{pri}}(l)$ are the *principal ports*, or *conclusions*, of l in Φ ;
- $\mathbf{P}_{\Phi}^{\text{aux}}: \mathcal{C}_{\Phi} \rightarrow \mathcal{P}(\mathcal{P}_{\Phi})$ is a function such that, for all $l, l' \in \mathcal{C}_{\Phi}$,
 - if $l \neq l'$ then $\mathbf{P}_{\Phi}^{\text{aux}}(l) \cap \mathbf{P}_{\Phi}^{\text{aux}}(l') = \emptyset$,
 - if $\text{tc}_{\Phi}(l) \in \{1, \perp, ax\}$ then $\text{card}(\mathbf{P}_{\Phi}^{\text{aux}}(l)) = 0$; if $\text{tc}_{\Phi}(l) \in \{\otimes, \wp, cut\}$ then $\text{card}(\mathbf{P}_{\Phi}^{\text{aux}}(l)) = 2$;
 for any $l \in \mathcal{C}_{\Phi}$, the elements of $\mathbf{P}_{\Phi}^{\text{aux}}(l)$ are the *auxiliary ports*, or *premises*, of l in Φ ;
- $\mathbf{P}_{\Phi}^{\text{left}}: \mathcal{C}_{\Phi}^{\otimes, \wp} \rightarrow \mathcal{P}_{\Phi}$ is a function such that $\mathbf{P}_{\Phi}^{\text{left}}(l) \in \mathbf{P}_{\Phi}^{\text{aux}}(l)$ for any $l \in \mathcal{C}_{\Phi}^{\otimes, \wp}$;
- $\text{tp}_{\Phi}: \mathcal{P}_{\Phi} \rightarrow \mathcal{F}_{\text{MELL}}$ is a function (we write $p: A$ and we say that A is the *type* of p , when $\text{tp}_{\Phi}(p) = A$) such that, for any $l \in \mathcal{C}_{\Phi}$, one has
 - if $\text{tc}_{\Phi}(l) = ax$ (resp. $\text{tc}_{\Phi}(l) = cut$) and $\mathbf{P}_{\Phi}^{\text{pri}}(l) = \{p_1, p_2\}$ (resp. $\mathbf{P}_{\Phi}^{\text{aux}}(l) = \{p_1, p_2\}$), then $\text{tp}_{\Phi}(p_1) = A$ and $\text{tp}_{\Phi}(p_2) = A^{\perp}$, for some $A \in \mathcal{F}_{\text{MELL}}$,
 - if $\text{tc}_{\Phi}(l) = A \in \{1, \perp\}$ and $\mathbf{P}_{\Phi}^{\text{pri}}(l) = \{p\}$, then $\text{tp}_{\Phi}(p) = A$,
 - if $\text{tc}_{\Phi}(l) = \odot \in \{\otimes, \wp\}$, $\mathbf{P}_{\Phi}^{\text{pri}}(l) = \{p\}$, $\mathbf{P}_{\Phi}^{\text{aux}}(l) = \{p_1, p_2\}$ and $\mathbf{P}_{\Phi}^{\text{left}}(l) = p_1$, then $\text{tp}_{\Phi}(p) = \text{tp}_{\Phi}(p_1) \odot \text{tp}_{\Phi}(p_2)$,
 - if $\text{tc}_{\Phi}(l) = \diamond \in \{!, ?\}$, $\mathbf{P}_{\Phi}^{\text{pri}}(l) = \{p\}$ and $\mathbf{P}_{\Phi}^{\text{aux}}(l) = \{p_1, \dots, p_n\}$ (with $n \in \mathbb{N}$), then $\text{tp}_{\Phi}(p) = \diamond A$ and $\text{tp}_{\Phi}(p_i) = A$ for all $1 \leq i \leq n$, for some $A \in \mathcal{F}_{\text{MELL}}$;
- $\mathcal{C}_{\Phi}^{\text{box}} \subseteq \{l \in \mathcal{C}_{\Phi}^! \mid \text{card}(\mathbf{P}_{\Phi}^{\text{aux}}(l)) = 1\}$, the elements of $\mathcal{C}_{\Phi}^{\text{box}}$ are the *box-cells* of Φ ; for any $l \in \mathcal{C}_{\Phi}^{\text{box}}$, its (unique) premise is denoted by $\text{prid}_{\Phi}(l)$ and called the *principal door* or *pri-door* of the box of l (in R); we set $\text{Doors}_{\Phi}^! = \bigcup \overline{\mathbf{P}_{\Phi}^{\text{aux}}}(\mathcal{C}_{\Phi}^{\text{box}})$;²
- $\text{box}_{\Phi}: (\bigcup \overline{\mathbf{P}_{\Phi}^{\text{aux}}}(\mathcal{C}_{\Phi}^{!, cut}) \cup \text{Doors}_{\Phi}^!) \rightarrow \mathcal{C}_{\Phi}^{\text{box}}$ is a partial function such that $\text{Doors}_{\Phi}^! \subseteq \text{dom}(\text{box}_{\Phi})$ and $\text{box}_{\Phi}(\text{prid}_{\Phi}(l)) = l$ for all $l \in \mathcal{C}_{\Phi}^{\text{box}}$.³

We set: $\mathcal{P}_{\Phi}^{\text{aux}} = \bigcup \text{im}(\mathbf{P}_{\Phi}^{\text{aux}})$, whose elements are the *auxiliary ports* of Φ ; $\mathcal{P}_{\Phi}^{\text{free}} = \mathcal{P}_{\Phi} \setminus \mathcal{P}_{\Phi}^{\text{aux}}$, whose elements are the *free ports*, or *conclusions*, of Φ ; and $\mathcal{C}_{\Phi}^{\text{free}} = \{l \in \mathcal{C}_{\Phi} \mid \mathbf{P}_{\Phi}^{\text{pri}}(l) \subseteq \mathcal{P}_{\Phi}^{\text{free}}\}$, whose elements are the *free*, or *terminal*, cells of Φ .⁴

For any pps Φ , the *ground-structure* (gs for short) of Φ is the 7-tuple $G_{\Phi} = (\mathcal{P}_{\Phi}, \mathcal{C}_{\Phi}, \text{tc}_{\Phi}, \mathbf{P}_{\Phi}^{\text{pri}}, \mathbf{P}_{\Phi}^{\text{aux}}, \mathbf{P}_{\Phi}^{\text{left}}, \text{tp}_{\Phi})$.

A pps Φ is *fat* (resp. *strongly fat*) if $\text{card}(\mathbf{P}_{\Phi}^{\text{aux}}(l)) \geq 1$ (resp. $\text{card}(\mathbf{P}_{\Phi}^{\text{aux}}(l)) \geq 2$) for all $l \in \mathcal{C}_{\Phi}^!$.

Let us make some comments on Def. 1. Let Φ be a pps.

- The function $\mathbf{P}_{\Phi}^{\text{left}}$ fixes an order on the two premises of any \otimes - and \wp -cell of Φ ; the premises of the other types of cells are unordered, as well as the conclusions of the *ax*-cells.
- The conditions $\bigcup \text{im}(\mathbf{P}_{\Phi}^{\text{pri}}) = \mathcal{P}_{\Phi}$ and “for all $l, l' \in \mathcal{C}_{\Phi}$, if $l \neq l'$ then $\mathbf{P}_{\Phi}^{\text{pri}}(l) \cap \mathbf{P}_{\Phi}^{\text{pri}}(l') = \emptyset = \mathbf{P}_{\Phi}^{\text{aux}}(l) \cap \mathbf{P}_{\Phi}^{\text{aux}}(l')$ ” mean that every port is conclusion of exactly one cell and premise of at most one cell; the elements of $\mathcal{P}_{\Phi}^{\text{free}}$ are the ports of Φ that are not premises of any cell.
- No condition is required for $\text{card}(\mathbf{P}_{\Phi}^{\text{aux}}(l))$ when $l \in \mathcal{C}_{\Phi}^{!, ?}$: l can have $n \in \mathbb{N}$ premises since we use generalized ?- and !-cells for (co-)contraction, (co-)weakening and (co-)dereliction.
- The gs G_{Φ} of Φ is obtained from Φ by forgetting box_{Φ} and $\mathcal{C}_{\Phi}^{\text{box}}$. In a way, G_{Φ} encodes the “geometric structure” of Φ (see below).

² Hence, $\text{Doors}_{\Phi}^! = \{\text{prid}_{\Phi}(l) \mid l \in \mathcal{C}_{\Phi}^{\text{box}}\}$, the set of premises of all *box*-cells of Φ .

³ So, box_{Φ} is defined on $\text{Doors}_{\Phi}^!$ and maps the (unique) premise of a *box*-cell l into l itself.

⁴ Thus, a cell l of a pps Φ is in $\mathcal{C}_{\Phi}^{\text{free}}$ iff either l is a *ax*-cell and both its conclusions are in $\mathcal{P}_{\Phi}^{\text{free}}$, or l is a *cut*-cell, or l is neither an *ax*- nor a *cut*-cell and its unique conclusion is in $\mathcal{P}_{\Phi}^{\text{free}}$.

For any pps Φ , the fact that box_Φ is defined on $\text{Ddoors}_\Phi^!$ is not needed but it simplifies the definition of the function $\text{box}_{\mathcal{P}_\Phi}^{\text{ext}}$ (Def. 8), an extension of box_Φ that will be useful in the sequel. Provided that some suitable conditions are fulfilled (Def. 10), any *box*-cell l of Φ is the starting point to compute the box associated with l : the partial function box_Φ allows to recover the border of this box. In general, not all !-cells of Φ with exactly one premise are *box*-cells.

► **Notation.** For any pps Φ we set $\text{Ddoors}_\Phi = \text{dom}(\text{box}_\Phi)$ and $\text{Ddoors}_\Phi^? = \text{Ddoors}_\Phi \cup \bigcup \overline{\mathcal{P}_\Phi^{\text{aux}}}(\mathcal{C}_\Phi^?)$, $\text{Ddoors}_\Phi^{\text{cut}} = \text{Ddoors}_\Phi \cap \bigcup \overline{\mathcal{P}_\Phi^{\text{aux}}}(\mathcal{C}_\Phi^{\text{cut}})$ and $\mathcal{C}_\Phi^{\text{bord}} = \mathcal{C}_\Phi^{\text{box}} \cup \{l \in \mathcal{C}_\Phi^? \mid \exists p \in \text{Ddoors}_\Phi^? \cap \mathcal{P}_\Phi^{\text{aux}}(l)\}$. From now on, $\bullet \notin \mathcal{C}_\Phi$ (in particular, $\bullet \notin \mathcal{C}_\Phi^{\text{box}}$) for any pps Φ .

With the gs G_Φ of any pps Φ is naturally associated a directed labeled graph $\mathfrak{G}(G_\Phi)$: its nodes are the cells of Φ , labeled by their type; its oriented edges are the ports of Φ , labeled by their type; a premise (resp. conclusion) of a cell l is incoming in (resp. outgoing from) l .

In the graphical representation of a pps Φ , a dotted arrow is depicted from a premise q of a ?-cell or *cut*-cell to the premise of a *box*-cell l when $q \in \text{box}_\Phi^{-1}(l)$. In pictures, the label of a *box*-cell is marked as ! p , and the names or types of ports and cells are sometimes omitted.

► **Definition 2** ((Pre-)order on the ports of a pre-proof-structure). Let Φ be a gs. The binary relation $<_{\frac{1}{\Phi}}$ on \mathcal{P}_Φ is defined by: $p <_{\frac{1}{\Phi}} q$ if there exists $l \in \mathcal{C}_\Phi$ such that $p \in \mathcal{P}_\Phi^{\text{pri}}(l)$ and $q \in \mathcal{P}_\Phi^{\text{aux}}(l)$. The preorder relation \leq_Φ on \mathcal{P}_Φ is the reflexive-transitive closure of $<_{\frac{1}{\Phi}}$. When $p \leq_\Phi q$ we say that q is *above* p . We write $p <_\Phi q$ if $p \leq_\Phi q$ and $p \neq q$.

In a pps Φ , the binary relation \leq_Φ has a geometric meaning (note that $\mathcal{C}_\Phi^{\text{box}}$ and box_Φ , as well as tc_Φ , $\mathcal{P}_\Phi^{\text{left}}$ and tp_Φ , play no role in Def. 2): for any $p, q \in \mathcal{P}_\Phi$, if $p \leq_\Phi q$ then in the directed graph $\mathfrak{G}(G_\Phi)$ there is a directed path from q to p that does not cross any *ax*- or *cut*-cell.

► **Remark 3** (Predecessor of a port). Let Φ be a pps. For all $p \in \mathcal{P}_\Phi^{\text{aux}} \setminus \overline{\mathcal{P}_\Phi^{\text{aux}}}(\mathcal{C}_\Phi^{\text{cut}})$, there is a unique $q \in \mathcal{P}_\Phi$ (denoted by $\text{pred}_\Phi(p)$, the *predecessor of* p) such that $q <_{\frac{1}{\Phi}} p$; moreover $\text{pred}_\Phi(p) \neq p$. Indeed, by hypothesis p is a premise of some cell of Φ , but the only cells with more than one conclusion are the *ax*-cells, which have no premises; so, p is a premise of a cell of Φ having just one conclusion q ; also, $\text{tp}_\Phi(p)$ is a proper subformula of $\text{tp}_\Phi(q)$, thus $p \neq q$.

► **Fact 4** (Tree-like order on ports). Let Φ be a pps: \leq_Φ is a tree-like order relation on \mathcal{P}_Φ .

According to Fact 4, a pps Φ cannot have “vicious cycles” like for example a cell l such that $\mathcal{P}_\Phi^{\text{pri}}(l) \cap \mathcal{P}_\Phi^{\text{aux}}(l) \neq \emptyset$ (i.e. a port cannot be both a premise and a conclusion of a cell l).

The names of ports and cells of a pps (ports and cells being nothing but their names) will be important to define the labeled Taylor expansion (Def. 13), a more informative variant of the usual Taylor expansion (Def. 18). Nevertheless, a precise answer to the question “When two pps can be considered equal?” leads naturally to the notion of isomorphism between pps (Def. 5), inspired by the notion of isomorphism between graphs: intuitively, two pps are isomorphic if they are identical up to the names of their ports and cells.

► **Definition 5** (Isomorphism on ground-structures and pre-proof-structures). Let Φ, Ψ be pps.

An *isomorphism from* G_Φ to G_Ψ is a pair $\varphi = (\varphi_{\mathcal{P}}, \varphi_{\mathcal{C}})$ of bijections $\varphi_{\mathcal{P}}: \mathcal{P}_\Phi \rightarrow \mathcal{P}_\Psi$ and $\varphi_{\mathcal{C}}: \mathcal{C}_\Phi \rightarrow \mathcal{C}_\Psi$ such that the diagrams in Fig. 2a commute. We write then $\varphi: G_\Phi \simeq G_\Psi$.

An *isomorphism from* Φ to Ψ is a pair $\varphi = (\varphi_{\mathcal{P}}, \varphi_{\mathcal{C}})$ of bijections $\varphi_{\mathcal{P}}: \mathcal{P}_\Phi \rightarrow \mathcal{P}_\Psi$ and $\varphi_{\mathcal{C}}: \mathcal{C}_\Phi \rightarrow \mathcal{C}_\Psi$ such that $\varphi: G_\Phi \simeq G_\Psi$, $\text{im}(\varphi_{\mathcal{C}}|_{\mathcal{C}_\Phi^{\text{box}}}) = \mathcal{C}_\Psi^{\text{box}}$, $\text{im}(\varphi_{\mathcal{P}}|_{\text{Ddoors}_\Phi}) = \text{Ddoors}_\Psi$ and the diagram in Fig. 2b commutes. We write then $\varphi: \Phi \simeq \Psi$.

If there is an isomorphism from Φ to Ψ , we say: Φ and Ψ are *isomorphic* and we write $\Phi \simeq \Psi$.

The relation \simeq is an equivalence on the set of pps. Equivalence classes for \simeq share the same graphical representation up to the order of the premises of their !- and ?-cells: any such representation can be seen as a canonical representative of an equivalence class.

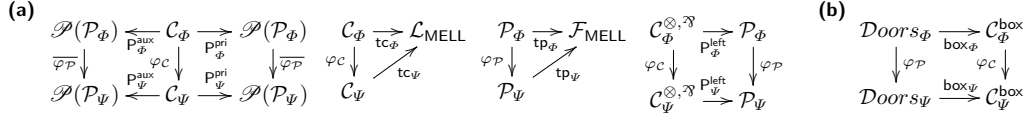

■ **Figure 2** Commutative diagrams for isomorphism of gs (Fig. 2a) and of pps (Fig. 2b). See Def. 5.

► **Remark 6.** Let Φ and Ψ be some pps with $\varphi = (\varphi_{\mathcal{P}}, \varphi_{\mathcal{C}}): G_\Phi \simeq G_\Psi$. We have:

1. $\text{card}(\mathcal{P}_\Phi^{\text{aux}}(l)) = \text{card}(\mathcal{P}_\Psi^{\text{aux}}(\varphi_{\mathcal{C}}(l)))$ for every $l \in \mathcal{C}_\Phi$, in particular Φ is fat (resp. strongly fat) iff Ψ is fat (resp. strongly fat); moreover, $\mathcal{P}_\Psi^{\text{free}} = \overline{\varphi_{\mathcal{P}}}(\mathcal{P}_\Phi^{\text{free}})$ and $\mathcal{C}_\Psi^{\text{free}} = \overline{\varphi_{\mathcal{C}}}(\mathcal{C}_\Phi^{\text{free}})$;
2. for every $p, q \in \mathcal{P}_\Phi$, $p \leq_\Phi q$ implies $\varphi_{\mathcal{P}}(p) \leq_\Psi \varphi_{\mathcal{P}}(q)$ ($\varphi_{\mathcal{P}}$ is non-decreasing).

DiLL-, DiLL₀- and MELL-proof-structures A pps Φ is a very “light” structure and in order to associate with any $l \in \mathcal{C}_\Phi^{\text{box}}$ the sub-pps of Φ usually called the box of l , some conditions need to be satisfied: for example, boxes have to be ordered by a tree-like order (nesting), *cut*- and *ax*-cells cannot cross the border of a box, *etc.* We introduce here some restrictions to pps in order to define proof-structures corresponding to some fragments or extension of LL: MELL, DiLL and DiLL₀. Full differential linear logic (DiLL) is an extension of MELL (with the same language as MELL) provided with both promotion rule (*i.e.* boxes) and co-structural rules (the duals of the structural rules handling the ?-modality) for the !-modality: DiLL₀ and MELL are particular subsystems of DiLL, respectively the promotion-free one (*i.e.* without boxes) and the one without co-structural rules. Our interest for DiLL is just to have an unitary syntax subsuming both MELL and DiLL₀ without considering cut-elimination: for this reason, unlike [16, 20], our DiLL-ps are not allowed to contain a set of DiLL-ps inside a box.

► **Definition 7** (DiLL₀-proof-structure). A DiLL₀-proof structure (DiLL₀-ps or *diffnet* for short) is a pps Φ with $\mathcal{C}_\Phi^{\text{box}} = \emptyset$. The set of DiLL₀-ps is denoted by $\mathbf{PS}_{\text{DiLL}_0}$, and ρ, σ, \dots range over it.

So, a DiLL₀-ps ρ is a pps without *box*-cells: in this case, box_ρ is the empty function. Thus, any DiLL₀-ps ρ can be identified with its gs G_ρ .

To define the conditions that a pps has to fulfill to be a DiLL-ps, we first extend the partial function box_Φ to a function $\text{box}_{\mathcal{P}_\Phi}^{\text{ext}}$ that associates with every port p of Φ the “deepest” *box*-cell (if any) whose box contains p ; it returns a dummy element \bullet if p is not contained in any box.

► **Definition 8** (Extension of box_Φ). Let Φ be a pps. The *extension of box_Φ* is a function $\text{box}_{\mathcal{P}_\Phi}^{\text{ext}}: \mathcal{P}_\Phi \rightarrow \mathcal{C}_\Phi^{\text{box}} \cup \{\bullet\}$ defined as follows: for any $p \in \mathcal{P}_\Phi$,

$$\text{box}_{\mathcal{P}_\Phi}^{\text{ext}}(p) = \begin{cases} \text{box}_\Phi(\max_{\leq_\Phi} (\downarrow_{\mathcal{P}_\Phi} p \cap \text{Doors}_\Phi)) & \text{if } \downarrow_{\mathcal{P}_\Phi} p \cap \text{Doors}_\Phi \neq \emptyset \\ \bullet & \text{otherwise.} \end{cases}$$

For every pps Φ , the function $\text{box}_{\mathcal{P}_\Phi}^{\text{ext}}$ is well-defined since, for all $p \in \mathcal{P}_\Phi$, the set $\downarrow_{\mathcal{P}_\Phi} p \cap \text{Doors}_\Phi$ is finite and totally ordered by \leq_Φ , according to Fact 4: therefore the greatest element of $\downarrow_{\mathcal{P}_\Phi} p \cap \text{Doors}_\Phi$ exists as soon as $\downarrow_{\mathcal{P}_\Phi} p \cap \text{Doors}_\Phi \neq \emptyset$.

In a pps Φ , computing $\text{box}_{\mathcal{P}_\Phi}^{\text{ext}}$ from box_Φ is simple. Given a port p of Φ , consider the maximal downwards path starting from p in the directed graph $\mathfrak{G}(G_\Phi)$: the first time the path bumps into a port $q \in \text{Doors}_\Phi$ (if any), we set $\text{box}_{\mathcal{P}_\Phi}^{\text{ext}}(p) = \text{box}_\Phi(q)$; if the path does not bump into any $q \in \text{Doors}_\Phi$, then $\text{box}_{\mathcal{P}_\Phi}^{\text{ext}}(p) = \bullet$.

► **Definition 9** (Preorder on *box*-cells of a pre-proof-structure). Let Φ be a pps. The binary relation $\leq_{\mathcal{C}_\Phi^{\text{box}}}$ on $\mathcal{C}_\Phi^{\text{box}}$ is defined by: $l \leq_{\mathcal{C}_\Phi^{\text{box}}} l'$ (say l' is above l) iff there are $p, p' \in \text{Doors}_\Phi$ such that $p \leq_\Phi p'$, $\text{box}_\Phi(p) = l$ and $\text{box}_\Phi(p') = l'$. We write $l <_{\mathcal{C}_\Phi^{\text{box}}} l'$ if $l \leq_{\mathcal{C}_\Phi^{\text{box}}} l'$ and $l \neq l'$.

The binary relation $\leq_{\mathcal{C}_\Phi^{\text{box}} \cup \{\bullet\}}$ on $\mathcal{C}_\Phi^{\text{box}} \cup \{\bullet\}$ is defined by: $l \leq_{\mathcal{C}_\Phi^{\text{box}} \cup \{\bullet\}} l'$ if either $l \leq_{\mathcal{C}_\Phi^{\text{box}}} l'$ or $l = \bullet$. We write $l <_{\mathcal{C}_\Phi^{\text{box}} \cup \{\bullet\}} l'$ when $l \leq_{\mathcal{C}_\Phi^{\text{box}} \cup \{\bullet\}} l'$ and $l \neq l'$.

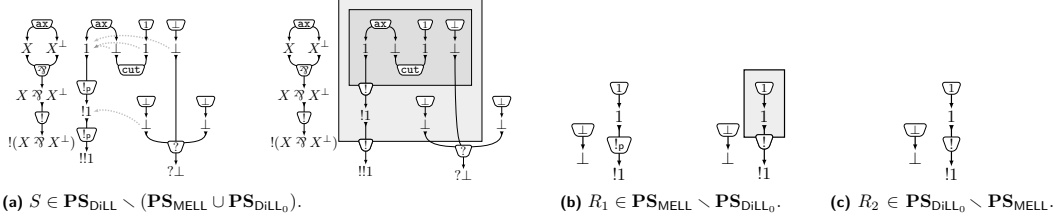

■ **Figure 3** Some examples of DiLL-ps. In R_1 (Fig. 3b) $\mathcal{C}_{R_1}^{\text{box}} = \{l\}$ and box_{R_1} is the empty function. In R_2 (Fig. 3c) $\mathcal{C}_{R_2}^{\text{box}} = \emptyset$, so box_{R_2} is the empty function. Both S (Fig. 3a) and R_1 (Fig. 3b) are in two different presentations: the “arrow-like” one (on the left) and the “inductive-like” one (on the right).

In any pps Φ , $\leq_{\mathcal{C}_\Phi^{\text{box}}}$ is a preorder on $\mathcal{C}_\Phi^{\text{box}}$, since \leq_Φ is a preorder on \mathcal{P}_Φ . The preorder $\leq_{\mathcal{C}_\Phi^{\text{box}} \cup \{\bullet\}}$ is the extension of $\leq_{\mathcal{C}_\Phi^{\text{box}}}$ obtained by adding \bullet as least element.

In Fig. 1d, Ξ is a pps such that $\leq_{\mathcal{C}_\Xi^{\text{box}}}$ is not an order on $\mathcal{C}_\Xi^{\text{box}}$; Ξ' is a pps such that $\leq_{\mathcal{C}_{\Xi'}^{\text{box}}}$ is an order but not a tree-like order on $\mathcal{C}_{\Xi'}^{\text{box}}$. A condition that a pps Φ must fulfill to be a DiLL-ps is just that $\leq_{\mathcal{C}_\Phi^{\text{box}}}$ is a tree-like order (or equivalently, $\leq_{\mathcal{C}_\Phi^{\text{box}} \cup \{\bullet\}}$ is a rooted tree-like order whose root is \bullet): this essentially amounts to the nesting of boxes (see [12] for details).

► **Definition 10** (DiLL-proof-structure and MELL-proof-structure). A *DiLL-proof-structure* (DiLL-ps for short) is a pps Φ such that:

1. $\leq_{\mathcal{C}_\Phi^{\text{box}}}$ is a tree-like order on $\mathcal{C}_\Phi^{\text{box}}$;
2. $\text{box}_{\mathcal{P}_\Phi^{\text{ext}}}(p) = \text{box}_{\mathcal{P}_\Phi^{\text{ext}}}(q)$ for all $l \in \mathcal{C}_\Phi^{\text{ax}}$ with $\text{P}_\Phi^{\text{pri}}(l) = \{p, q\}$ and all $l \in \mathcal{C}_\Phi^{\text{cut}}$ with $\text{P}_\Phi^{\text{aux}}(l) = \{p, q\}$;
3. for all $p \in \text{Doors}_\Phi^! \cup \text{Doors}_\Phi^?$, one has $\text{box}_\Phi(p) \neq \text{box}_{\mathcal{P}_\Phi^{\text{ext}}}(\text{pred}_\Phi(p))$;
4. for all $l \in \mathcal{C}_\Phi^{\text{box}} \cup \{\bullet\}$ and $p \in \text{Doors}_\Phi^!$, if $l <_{\mathcal{C}_\Phi^{\text{box}} \cup \{\bullet\}} \text{box}_\Phi(p)$ then $l \leq_{\mathcal{C}_\Phi^{\text{box}} \cup \{\bullet\}} \text{box}_{\mathcal{P}_\Phi^{\text{ext}}}(\text{pred}_\Phi(p))$.

A *MELL-proof-structure* (MELL-ps for short) is a DiLL-ps Φ such that $\mathcal{C}_\Phi^{\text{box}} = \mathcal{C}_\Phi^!$. The set of DiLL-ps (resp. MELL-ps) is denoted by $\mathbf{PS}_{\text{DiLL}}$ (resp. $\mathbf{PS}_{\text{MELL}}$) and R, S, \dots range over it.

In Def. 10, condition 2 means that a *cut*-cell (resp. *ax*-cell) cannot cross the border of a box, *i.e.* its premises (resp. conclusions) belong to the same boxes; the pps Φ in Fig. 1a does not fulfill condition 2. Condition 3 in Def. 10 entails that two ports on the border of the same box cannot be above each other (in the sense of \leq_Φ); the pps Ψ_1 and Ψ_2 in Fig. 1b do not fulfill condition 3. Condition 4 in Def. 10 implies that the border of a box cannot have more than one $!$ -cell: when the premise of a $!$ -cell l' belongs to the box associated with a *box*-cell $l \neq l'$, then l' is itself contained in the box of l . The pps X in Fig. 1c does not fulfill condition 4, even if it satisfies conditions 1-3. See [12] for more details.

In [12] we show that the information encoded in a DiLL-ps R is enough to associate a box R_l with any *box*-cell l of R . So, as usual for LL, R_l can be graphically depicted (instead of using dotted arrows to pick out $\text{box}_R^{-1}(l)$) by a rectangular frame containing all ports in $\text{inbox}_R(l)$ (see Def. 11). Some examples of DiLL-ps are in Fig. 3.

► **Definition 11** (Content of the box, depth). Let R be a DiLL-ps.

For any $l \in \mathcal{C}_R^{\text{box}}$, the *content of the box of l* is $\text{inbox}_R(l) = \{q \in \mathcal{P}_R \mid l \leq_{\mathcal{C}_R^{\text{box}}} \text{box}_{\mathcal{P}_R^{\text{ext}}}(q)\}$.

The function $\text{box}_{\mathcal{C}_R^{\text{ext}}}^{\text{ext}}: \mathcal{C}_R \rightarrow \mathcal{C}_R^{\text{box}}$ is defined by: for every $l \in \mathcal{C}_R \setminus \mathcal{C}_R^{\text{cut}}$ (resp. $l \in \mathcal{C}_R^{\text{cut}}$), we set $\text{box}_{\mathcal{C}_R^{\text{ext}}}^{\text{ext}}(l) = \text{box}_{\mathcal{P}_R^{\text{ext}}}(p)$ where $p \in \text{P}_R^{\text{pri}}(l)$ (resp. $p \in \text{P}_R^{\text{aux}}(l)$).⁵

⁵ For every $l \in \mathcal{C}_R$, $\text{box}_{\mathcal{C}_R^{\text{ext}}}^{\text{ext}}(l)$ is well-defined by condition 2 in Def. 10. Note that, for any $l \in \mathcal{C}_R^{\text{box}}$, $\text{box}_{\mathcal{C}_R^{\text{ext}}}^{\text{ext}}(l)$ is the immediate predecessor of l in the tree-like order $\leq_{\mathcal{C}_R^{\text{box}} \cup \{\bullet\}}$.

For every $p \in \mathcal{P}_R$ and $l \in \mathcal{C}_R$, the *depths of p and l in R* are defined as follows: $\text{depth}_{\mathcal{P}_R}(p) = \text{card}(\downarrow_{\mathcal{C}_R^{\text{box}}}(\text{box}_{\mathcal{P}_R}^{\text{ext}}(p)))$ and $\text{depth}_{\mathcal{C}_R}(l) = \text{card}(\downarrow_{\mathcal{C}_R^{\text{box}}}(\text{box}_{\mathcal{C}_R}^{\text{ext}}(l)))$.

The *depth of R* is the natural number $\text{depth}(R) = \sup\{\text{depth}_{\mathcal{P}_R}(p) \mid p \in \mathcal{P}_R\}$.

Given a DiLL-ps R , for any *box-cell* l in R , $\text{inbox}_R(l)$ represents the set of ports contained in the box of l . According to Definition 11, the meaning of $\text{box}_{\mathcal{P}_R}^{\text{ext}}$ is clear: for any port p of R , $\downarrow_{\mathcal{C}_R^{\text{box}}}(\text{box}_{\mathcal{P}_R}^{\text{ext}}(p)) = \{l \in \mathcal{C}_R^{\text{box}} \mid p \in \text{inbox}_R(l)\}$ is the set of boxes in R containing p , and if $\text{box}_{\mathcal{P}_R}^{\text{ext}}(p) = \bullet$ then p has depth 0 (no box in R contains p), otherwise $\text{box}_{\mathcal{P}_R}^{\text{ext}}(p)$ is the deepest *box-cell* in R whose box contains p ; the depth of p in R is the number of nested boxes in R containing p . According to Def. 11, for any *box-cell* l , $\text{depth}_{\mathcal{P}_R}(\text{prid}_R(l)) = \text{depth}_{\mathcal{C}_R}(l) + 1$.

In a DiLL-ps R the ports in $\text{Doors}_R^! \cup \text{Doors}_R^?$ are the ones in the border of some box: more precisely, for any $p \in \text{Doors}_R^! \cup \text{Doors}_R^?$, p is in the border of the box of every *box-cell* l of R such that $\text{box}_{\mathcal{P}_R}^{\text{ext}}(\text{pred}_R(p)) <_{\mathcal{C}_R^{\text{box}} \cup \{\bullet\}} l \leq_{\mathcal{C}_R^{\text{box}}} \text{box}_{\mathcal{P}_R}^{\text{ext}}(p)$. By conditions 1 and 3-4 in Def. 10, (the premise of) a *box-cell* is in the border of exactly one box: for any $l \in \mathcal{C}_R^{\text{box}}$ with $\text{P}_R^{\text{pri}}(l) = \{p\}$, one has $\text{box}_{\mathcal{P}_R}^{\text{ext}}(p) <_{\mathcal{C}_R^{\text{box}} \cup \{\bullet\}} l$ and there is no $l' \in \mathcal{C}_R^{\text{box}} \cup \{\bullet\}$ such that $\text{box}_{\mathcal{P}_R}^{\text{ext}}(p) <_{\mathcal{C}_R^{\text{box}} \cup \{\bullet\}} l' <_{\mathcal{C}_R^{\text{box}} \cup \{\bullet\}} l$. This does not hold in general for $?$ -cells in $\mathcal{C}_R^{\text{bord}}$, since we use generalized $?$ -links: a premise of a $?$ -cell can cross the border of several boxes, see for instance one of the premises of the $?$ -cell whose conclusion is of type $?\perp$ in Fig. 3a.

3 Computing the Taylor expansion of a DiLL-proof-structure

The Taylor expansion of a MELL-ps, or more generally a DiLL-ps, R is a (usually infinite) set of DiLL₀-ps: roughly speaking, each element of the Taylor expansion of R is obtained from R by replacing each box B in R with n_B copies of its content (for some $n_B \in \mathbb{N}$), recursively on the depth of R . Note that n_B depends not only on B but also on which “copy” of the contents of all boxes containing B we are considering. Usually, the Taylor expansion of MELL-ps [15, 17] is defined globally and inductively: with every MELL-ps R is directly associated its Taylor expansion (the whole set!) by induction on the depth of R . We adopt an alternative approach, which is pointwise and non-inductive: visually, it is exemplified by Fig. 4.

We introduce here *Taylor-functions*: a Taylor-function of a DiLL-ps R ascribes recursively a number of copies for each box of R . Any element of the Taylor expansion of R can be built from (at least) one element of the *proto-Taylor expansion* $\mathcal{T}_R^{\text{proto}}$ of R , $\mathcal{T}_R^{\text{proto}}$ being the set of Taylor-functions of R . We build in this way a more informative version of the Taylor expansion of R , the *labeled Taylor-expansion* \mathcal{T}_R of R : one of the advantages of our pointwise and non-inductive approach is that it is easy to define the correspondence between ports and cells of any element ρ of the Taylor expansion of R and ports and cells of R (an operation intuitively clear but very awkward to define with the global and inductive approach), and to differentiate the various copies in ρ of the content of a same box in R . For this purpose, any port (or cell) of any DiLL₀-ps in the labeled Taylor expansion of R is of the shape (p, a) , where p is the corresponding port (or cell) of R and the finite sequence a has to be intended as a list of indexes saying in which copy of the content of each box (p, a) is. These indexes are a syntactic counterpart of the ones used in the definition of k -experiment of PLPS in [5, Def. 35]. The information encoded in any element of the labeled Taylor expansion will be useful to prove some fundamental lemmas in §4. The usual Taylor expansion of a DiLL-ps R (whose elements do not contain this information, Def. 18) is then the quotient of \mathcal{T}_R modulo isomorphism, *i.e.* modulo renaming of ports and cells of any DiLL₀-ps in \mathcal{T}_R .

► **Definition 12** (Taylor-function of a DiLL-proof-structure). Let R be a DiLL-ps.

A *Taylor-function* of R is a function $f: \mathcal{C}_R^{\text{box}} \cup \{\bullet\} \rightarrow \mathcal{P}_{\text{fin}}(\mathbb{N}^*)$ such that:

1. (*depth compatibility*) $f(\bullet) = \{(\)\}$ and $|a| = \text{depth}_{\mathcal{P}_R}(\text{prid}_R(l))$, for any $l \in \mathcal{C}_R^{\text{box}}$ and $a \in f(l)$;
2. (*vertical downclosure*) for all $l, l' \in \mathcal{C}_R^{\text{box}}$ such that $l \leq_{\mathcal{C}_R^{\text{box}}} l'$, with $k = \text{depth}_{\mathcal{P}_R}(\text{prid}_R(l))$ and $k' = \text{depth}_{\mathcal{P}_R}(\text{prid}_R(l'))$ (so $k \leq k'$), if $(n_1, \dots, n_k, \dots, n_{k'}) \in f(l')$ then $(n_1, \dots, n_k) \in f(l)$.

The *proto-Taylor expansion* of R is the set $\mathcal{T}_R^{\text{proto}}$ of Taylor-functions of R .

Note that the notion of Taylor-function of a DiLL-ps R relies only on the tree-like order on $\mathcal{C}_R^{\text{box}}$, hence we could define the Taylor-function of any tree. By the vertical downclosure condition, any Taylor-function of a DiLL-ps R can be naturally presented as a tree-like order which is an “level-by-level expansion” of the tree-like order on $\mathcal{C}_R^{\text{box}}$: see Fig. 4a-4c.

Our approach in defining the elements of the Taylor expansion of a DiLL-ps R separates the analysis of the number of copies to take for each (copy of) box of R (every Taylor-function of R contains this information, which is the most important one) from the operation of copying the content of each box (given by the function τ_R defined below). Indeed, with any Taylor-function of R one can associate a unique element of the (labeled) Taylor expansion of R (Def. 13).

► **Definition 13** (Labeled Taylor expansion). Let R be a DiLL-ps.

The function $\tau_R: \mathcal{T}_R^{\text{proto}} \rightarrow \mathbf{PS}_{\text{DiLL}_0}$ associates with any $f \in \mathcal{T}_R^{\text{proto}}$ a DiLL₀-ps $\tau_R(f)$ defined by: $\mathcal{C}_{\tau_R(f)}^{\text{box}} = \emptyset$, $\text{box}_{\tau_R(f)}$ is the empty function, and

$$\begin{aligned} \mathcal{P}_{\tau_R(f)} &= \{(p, a) \mid p \in \mathcal{P}_R \text{ and } a \in f(\text{box}_{\mathcal{P}_R}^{\text{ext}}(p))\} \\ \mathcal{C}_{\tau_R(f)} &= \{(l, a) \mid l \in \mathcal{C}_R \text{ and } a \in f(\text{box}_{\mathcal{C}_R}^{\text{ext}}(l))\} \\ \text{tc}_{\tau_R(f)}((l, a)) &= \text{tc}_R(l) \quad \text{for every } (l, a) \in \mathcal{C}_{\tau_R(f)} \\ \mathcal{P}_{\tau_R(f)}^{\text{pri}}((l, a)) &= \{(p, a) \mid p \in \mathcal{P}_R^{\text{pri}}(l)\} \quad \text{for every } (l, a) \in \mathcal{C}_{\tau_R(f)} \\ \mathcal{P}_{\tau_R(f)}^{\text{aux}}((l, a)) &= \{(p, b) \mid p \in \mathcal{P}_R^{\text{aux}}(l), a \sqsubseteq b \in f(\text{box}_{\mathcal{P}_R}^{\text{ext}}(p))\} \quad \text{for any } (l, a) \in \mathcal{C}_{\tau_R(f)} \\ \mathcal{P}_{\tau_R(f)}^{\text{left}}((l, a)) &= (\mathcal{P}_R^{\text{left}}(l), a) \quad \text{for every } (l, a) \in \mathcal{C}_{\tau_R(f)}^{\otimes, \mathfrak{X}} \\ \text{tp}_{\tau_R(f)}((p, a)) &= \text{tp}_R(p) \quad \text{for every } (p, a) \in \mathcal{P}_{\tau_R(f)} \end{aligned}$$

The *labeled Taylor expansion* of R is the set of DiLL₀-ps $\mathcal{T}_R = \text{im}(\tau_R)$.

The proof that $\tau_R(f)$ is a DiLL₀-ps for any DiLL-ps R and any Taylor-function f of R , is left to the reader. The set \mathcal{T}_R (as well as $\mathcal{T}_R^{\text{proto}}$) is infinite iff $\text{depth}(R) > 0$.

Note that when $l \in \mathcal{C}_R^{\text{bord}}$, the condition $a \sqsubseteq b$ when defining $\mathcal{P}_{\tau_R(f)}^{\text{aux}}((l, a))$ in Def. 13 plays a crucial role: for instance, given the MELL-ps R as in Fig. 4a and the Taylor-function f of R as in Fig. 4c, the premises of the !-cell $(l_1, (1))$ of $\tau_R(f)$ (whose conclusion is $(r_1, (1))$ in Fig. 4d) are $(p_1, (1, 1))$, $(p_1, (1, 2))$, $(p_1, (1, 3))$, and not $(p_1, (2, 1))$, since $(1) \not\sqsubseteq (2, 1)$.

► **Remark 14** (Canonicity). Given a DiLL-ps R and $f \in \mathcal{T}_R^{\text{proto}}$, we say that f is *canonical* if

- (*horizontal downclosure*) for every $l \in \mathcal{C}_R^{\text{box}}$, if $(n_1, \dots, n_m) \in f(l)$ then $n_1, \dots, n_m \in \mathbb{N}^+$ and $(n_1, \dots, n_{m-1}, k) \in f(l)$ for any $1 \leq k \leq n_m$.

A $\rho \in \mathcal{T}_R$ is *canonical* if $\rho = \tau_R(f)$ for some canonical $f \in \mathcal{T}_R^{\text{proto}}$. In any canonical DiLL₀-ps of \mathcal{T}_R the various copies of the content of a box are numbered sequentially starting from 1. It can easily be shown that for any $\rho \in \mathcal{T}_R$, there is a canonical $\sigma \in \mathcal{T}_R$ such that $\rho \simeq \sigma$.

The next example shows how to compute an element ρ of the labeled Taylor expansion of a DiLL-ps R starting from R and a Taylor-function of R . It shows also the information encoded in ρ with respect to R : the correspondence between ports (and cells) of ρ and ports (and cells) of R , and the differentiation of the various copies in ρ of the content of a same box in R .

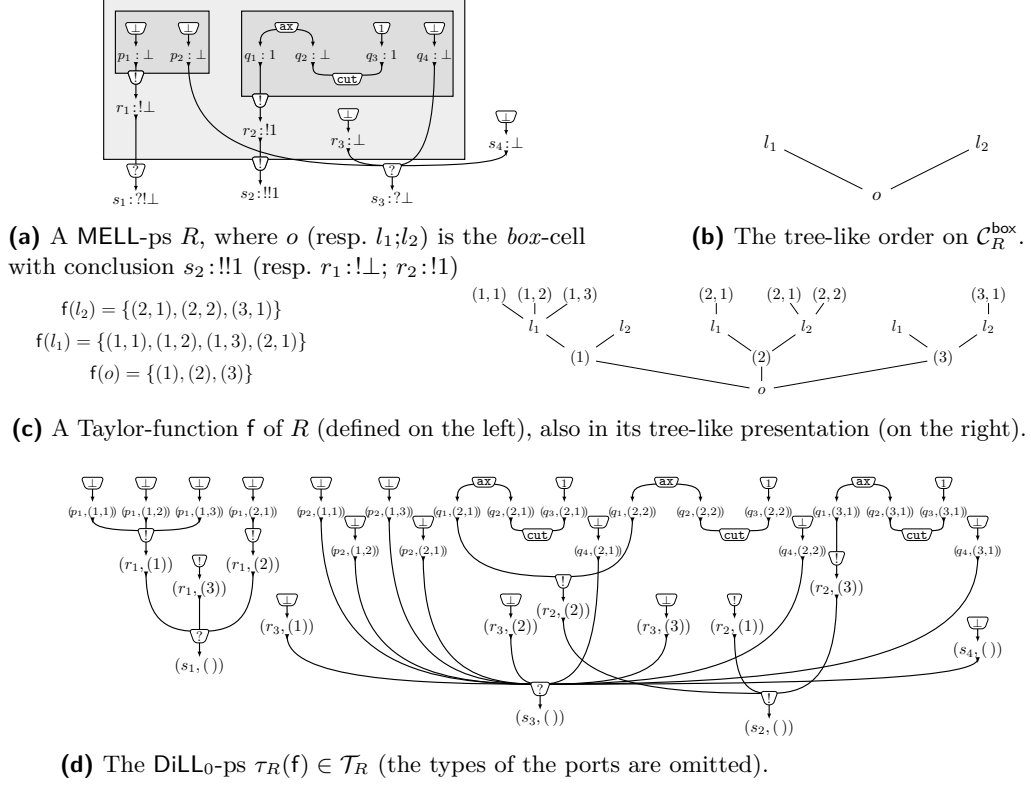

■ **Figure 4** From a MELL-ps R (Fig. 4a) to an element of the labeled Taylor expansion of R (Fig. 4d), via a Taylor-function of R (Fig. 4c). See also Example 15.

► **Example 15.** Let R be the MELL-ps as in Fig. 4a (the tree-like order on $\mathcal{C}_R^{\text{box}}$ is in Fig. 4b) and f be the Taylor-function of R as in Fig. 4c. The DiLL-ps $\tau_R(f) \in \mathcal{T}_R$ obtained from f by applying Def. 13 is in Fig. 4d. Note that the ports $(p_2, (1, 2))$ and $(p_2, (2, 1))$ are two ports of $\tau_R(f)$ corresponding to the port p_2 of R : more precisely, $(p_2, (1, 2))$ (resp. $(p_2, (2, 1))$) is in the second (resp. first) copy of the content of the box of l_1 which is in the first (resp. second) copy of the content of o . Analogously for the other ports and cells of $\tau_R(f)$.

► **Definition 16 (Forgetful functions).** Let $R \in \mathbf{PS}_{\text{DiLL}}$ and $\rho \in \mathcal{T}_R$. The *forgetful functions* $\text{forget}_{\mathcal{P}}^{\rho, R}: \mathcal{P}_{\rho} \rightarrow \mathcal{P}_R$ and $\text{forget}_{\mathcal{C}}^{\rho, R}: \mathcal{C}_{\rho} \rightarrow \mathcal{C}_R$ are defined by: $\text{forget}_{\mathcal{P}}^{\rho, R}((p, a)) = p$ and $\text{forget}_{\mathcal{C}}^{\rho, R}((l, b)) = l$ for all $(p, a) \in \mathcal{P}_{\rho}$ and $(l, b) \in \mathcal{C}_{\rho}$.

By forgetting the indexes associated with the ports and cells of $\rho \in \mathcal{T}_R$, the functions $\text{forget}_{\mathcal{P}}^{\rho, R}$ and $\text{forget}_{\mathcal{C}}^{\rho, R}$ make explicit the correspondence (neither injective nor surjective) between ports and cells of ρ and ports and cells of R , implicitly given in Def. 13.

Given $f \in \mathcal{T}_R^{\text{proto}}$ such that $\rho = \tau_R(f) \in \mathcal{T}_R$, the functions $f \circ \text{box}_{\mathcal{P}_R}^{\text{ext}}$ and $f \circ \text{box}_{\mathcal{C}_R}^{\text{ext}}$ are some kind of “inverses” of $\text{forget}_{\mathcal{P}}^{\rho, R}$ and $\text{forget}_{\mathcal{C}}^{\rho, R}$, respectively: with every port and cell of R , they associate the set of indexes of their corresponding ports and cells of ρ . In other words, for every port p and cell l of R , $f(\text{box}_{\mathcal{P}_R}^{\text{ext}}(p))$ and $f(\text{box}_{\mathcal{C}_R}^{\text{ext}}(l))$ are the sets of the “tracking numbers” of the copies of (the content of the boxes containing) p and l in ρ .

► **Example 17.** Let R be the MELL-ps as in Figure 5a and let f and g be the Taylor-functions of R defined in Fig. 5b-5c. Obviously, $f \neq g$, $\tau_R(f) \neq \tau_R(g)$ (indeed, $(p, (2, 2)) \in \mathcal{P}_{\tau_R(f)} \setminus \mathcal{P}_{\tau_R(g)}$, see Fig. 5d-5e) but $\tau_R(f) \simeq \tau_R(g)$ (and $\tau_R(f), \tau_R(g) \in \mathcal{T}_R$).

For any DiLL-ps R , it can be shown that the function τ_R is injective. However, Example 17 shows that there may exist two different Taylor-functions of R whose images via τ_R are

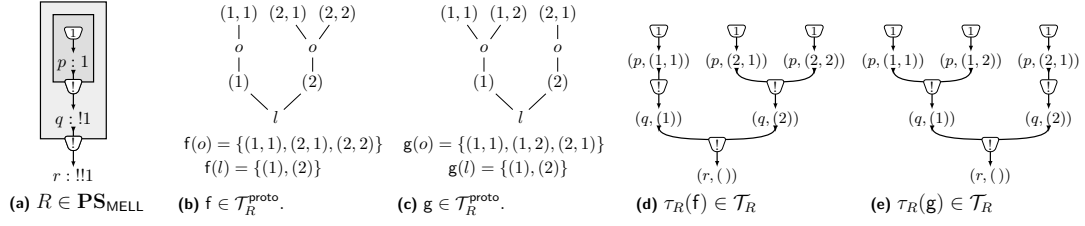

■ **Figure 5** A MELL-ps R (Fig. 5a) where o (resp. l) is the *box*-cell with conclusion $q:!!1$ (resp. $r:!!1$), and two different but isomorphic elements $\tau_R(f)$ (Fig. 5d) and $\tau_R(g)$ (Fig. 5e) of \mathcal{T}_R . See Example 17.

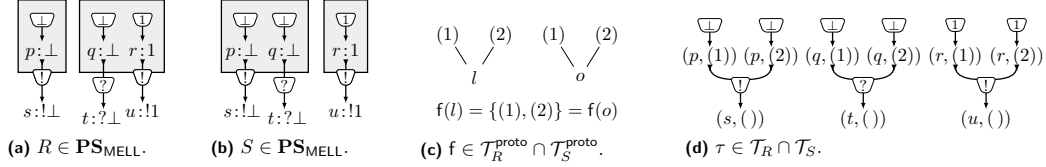

■ **Figure 6** Two non-isomorphic MELL-ps R (Fig. 6a) and S (Fig. 6b), where l (resp. o) is the *box*-cell of R and S with conclusion $s:!!1$ (resp. $u:!!1$). The DiLL₀-ps $\tau \in \mathcal{T}_R \cap \mathcal{T}_S$ (Fig. 6d) is the 2-diffnet of R and S generated by the Taylor-function f of R and S (Fig. 6c), *i.e.* $\tau_R(f) = \tau = \tau_S(f)$.

different but isomorphic: the labeled Taylor expansion of a DiLL-ps may contain several elements which are isomorphic and differ from each other only by the name of their ports and cells. Moreover, the Taylor expansion is not closed by isomorphism: from $\rho \in \mathcal{T}_R$ for some DiLL-ps R and $\sigma \simeq \rho$, it does not follow that $\sigma \in \mathcal{T}_R$ (and there might even exist a DiLL-ps $S \neq R$ with $\sigma \in \mathcal{T}_S$). Indeed, although ρ and σ are isomorphic as DiLL₀-ps, all information about R available in ρ thanks to the names of its ports and cells might very well be lost in σ .

The definition of Taylor expansion of a MELL-ps coming from [9] and used in [15, Def. 9] and [17, Def. 5] forgets all the information encoded in the names of ports and cells of each element of our labeled Taylor expansion.

► **Definition 18** (Taylor expansion of a DiLL-proof-structure). Let R be a DiLL-ps. The *Taylor expansion* of R is $\mathcal{T}_R^{\simeq} = \{\{\tau \in \mathbf{PS}_{\text{DiLL}_0} \mid \tau \simeq \rho\} \mid \rho \in \mathcal{T}_R\}$.

Let R be a DiLL-ps: the binary relation \approx_R on $\mathbf{PS}_{\text{DiLL}_0}$ defined by “ $\tau \approx_R \tau'$ iff there is $\rho \in \mathcal{T}_R$ such that $\tau \simeq \rho \simeq \tau'$ ” is a partial equivalence relation, and, for any $\rho \in \mathcal{T}_R$, $\{\tau \in \mathbf{PS}_{\text{DiLL}_0} \mid \tau \simeq \rho\}$ is a partial equivalence class on $\mathbf{PS}_{\text{DiLL}_0}$ modulo \approx_R . Morally, \mathcal{T}_R^{\simeq} is the quotient of \mathcal{T}_R modulo isomorphism, *i.e.* modulo renaming of ports and cells of each element of \mathcal{T}_R : any element of \mathcal{T}_R^{\simeq} can be seen as an element of \mathcal{T}_R where all the information encoded in the names of its ports and cells is forgotten. Clearly, if $R \simeq S$ then $\mathcal{T}_R^{\simeq} = \mathcal{T}_S^{\simeq}$.

Let us stress the differences between \mathcal{T}_R and \mathcal{T}_R^{\simeq} of a DiLL-ps R . Given a (co-)contraction cell l of $\rho \in \mathcal{T}_R$ (*i.e.* $l \in \mathcal{C}_\rho^{!/?}$ and $\text{card}(\mathbf{P}_\rho^{\text{aux}}(l)) \geq 2$), it is possible to distinguish if l is a “real” (co-)contraction (*i.e.* the corresponding $!$ - or $?$ -cell l' of R has at least 2 premises) or not (and then l' is in the border of some box and has only one premise which is in $\text{Doors}_R^! \cup \text{Doors}_R^?$): only in the first case there are two premises (p, a) and (q, b) of l with $p \neq q$. We can make this distinction via the information encoded in the names of ports and cells of $\rho \in \mathcal{T}_R$, but in general we are not able to do that in (any representative of) an element of \mathcal{T}_R^{\simeq} .

Nevertheless, the information encoded in the labeled Taylor expansion of a DiLL-ps has some limitations: in general, a DiLL-ps R is not completely characterized by any $\rho \in \mathcal{T}_R$ (even if ρ is R -fat or strongly R -fat, see Def. 19 below), *i.e.* the fact that $\rho \in \mathcal{T}_R \cap \mathcal{T}_S$ for some DiLL-ps R and S does not imply $R \simeq S$. For instance, the DiLL₀-ps τ in Fig. 6d is an element of both \mathcal{T}_R and \mathcal{T}_S , where R and S are as in Fig. 6a and 6b, respectively.

Elements of special interest of the (labeled) Taylor expansion of a DiLL proof-structure

► **Definition 19** (*R-fatness, k-diffnet of a DiLL-ps*). Let $R \in \mathbf{PS}_{\text{DiLL}}$, $\rho \in \mathcal{T}_R$ and $k \in \mathbb{N}$.

- ρ is *R-fat* (resp. *strongly R-fat*) if, for every $(l, b) \in \mathcal{C}_\rho^!$ such that $l \in \mathcal{C}_R^{\text{box}}$, one has $\text{card}(\mathbf{P}_\rho^{\text{aux}}((l, b))) \geq 1$ (resp. $\text{card}(\mathbf{P}_\rho^{\text{aux}}((l, b))) \geq 2$).
- ρ is a *k-diffnet of R* if $\text{card}(\mathbf{P}_\rho^{\text{aux}}((l, b))) = k$ for any $(l, b) \in \mathcal{C}_\rho^!$ such that $l \in \mathcal{C}_R^{\text{box}}$.
- The *element of order k of \mathcal{T}_R* is the $\rho_0 \in \mathcal{T}_R$ such that $\rho \in \rho_0$ for some *k-diffnet* ρ of R .

Given a DiLL-ps R and $\rho \in \mathcal{T}_R$: ρ is *R-fat* (resp. *strongly R-fat*) when ρ is obtained by taking at least one (resp. two) copies of the content of any box in R ; ρ is a *k-diffnet of R* when ρ is obtained by taking exactly k copies of the content of every box in R . Any *k-diffnet of R* with $k \geq 1$ (resp. $k \geq 2$) is *R-fat* (resp. *strongly R-fat*). Given $k \in \mathbb{N}$, all *k-diffnets of R* are isomorphic and there is a unique canonical *k-diffnet of R*; moreover, there is a unique element of order k in \mathcal{T}_R : the set of all DiLL₀-ps isomorphic to any *k-diffnet of R*. Following [5, Def. 16-17], it can be shown that the LPS of R is univocally determined by any *R-fat* $\rho \in \mathcal{T}_R$.

► **Fact 20** (*Isomorphism of gs*). Let $R, S \in \mathbf{PS}_{\text{DiLL}}$ and ρ (resp. σ) be a 1-diffnet of R (resp. S).

1. The functions $\text{forget}_P^{\rho, R}$ and $\text{forget}_C^{\rho, R}$ are bijective, and $(\text{forget}_P^{\rho, R}, \text{forget}_C^{\rho, R}): G_\rho \simeq G_R$.
2. Suppose $\varphi_1: \rho \simeq \sigma$. Let $\varphi_P: \mathcal{P}_R \rightarrow \mathcal{P}_S$ and $\varphi_C: \mathcal{C}_R \rightarrow \mathcal{C}_S$ be functions defined by: $\varphi_P = \text{forget}_P^{\sigma, S} \circ \varphi_{1P} \circ (\text{forget}_P^{\rho, R})^{-1}$ and $\varphi_C = \text{forget}_C^{\sigma, S} \circ \varphi_{1C} \circ (\text{forget}_C^{\rho, R})^{-1}$. Then, φ_P and φ_C are bijective and $(\varphi_P, \varphi_C): G_R \simeq G_S$.

The fact that $\rho \in \mathcal{T}_R$ for some DiLL-ps R and $\sigma \simeq \rho$ do not imply that $\sigma \in \mathcal{T}_R$ (and there may exist a DiLL-ps $S \not\simeq R$ such that $\sigma \in \mathcal{T}_S$). Indeed, all the information about R encoded in the names of ports and cells of ρ is lost in σ , since σ is “the same as ρ up to the names of ports and cells”. In general looking at σ one is not able to recognize where the border of the boxes in R are. Fact 20.2 only says that if R, S are DiLL-ps and ρ (resp. σ) is the 1-diffnet of R (resp. S) with $\varphi_1: \rho \simeq \sigma$, then φ_1 induces an isomorphism φ from the gs G_R of R to the gs G_S of S , but in general φ does not make the diagram in Fig. 2b (Def. 5) commute. This is not surprising, since a 1-diffnet of a DiLL-ps R is essentially the gs of R (Fact 20.1), *i.e.* R having forgotten the border of boxes in R .

4 Connected case: computing a MELL-ps from its Taylor expansion

We show here our main result (Thm. 28): a connected (in the sense of Def. 23) MELL-ps R is completely characterized by any $\gamma \in \mathcal{T}_R$ strongly fat.⁶ The idea is that, by means of the “geometry” of γ (the same in all elements of γ , since they are isomorphic), we can recover the information about R encoded in the names of ports and cells of some *suitable* $\rho \in \mathcal{T}_R \cap \gamma$: in particular, we can identify the “real” contraction cells from the “fake” ones. A key-tool for this approach is the notion of ?-accessibility (Def. 21): it allows to separate the different copies of the content of a box, so it plays at a syntactic level the same role played by bridges in [5, Def. 73]. Intuitively, in a pps Φ , q is a ?-accessible port from p if there is a path in $\mathfrak{G}(G_\Phi)$ seen as undirected graph (see page 5) starting upward from p and ending in q , paying attention that, when crossing downward a cell l with type ? (here “upward” and “downward” are in the sense of the order relation \leq_Φ of Def. 2), we require that all the premises of l are reachable by a path starting upward from p .

⁶ According to Def. 1, (strong) fatness is not defined for a set of pps, but this notion can be extended to a set of isomorphic pps thanks to Remark 6.1.

► **Definition 21** (?-path, ?-accessibility). Let Φ be a pps. A ?-path on Φ (from p_0 to p_n) is a finite sequence (p_0, \dots, p_n) of ports of Φ defined by induction as follows:

- (i) (p) is a ?-path for any $p \in \mathcal{P}_\Phi$;
- (ii) if $\vec{p} = (p_0, \dots, p_n)$ is a ?-path where $p_n \in \mathbb{P}_\Phi^{\text{pri}}(l)$ for some $l \in \mathcal{C}_\Phi$, then $\vec{p} \cdot q$ is a ?-path, for any $q \in (\mathbb{P}_\Phi^{\text{pri}}(l) \cup \mathbb{P}_\Phi^{\text{aux}}(l)) \setminus \{p_n\}$;
- (iii) if $\vec{p} = (p_0, \dots, p_n)$ is a ?-path with $p_n \in \mathbb{P}_\Phi^{\text{aux}}(l) \setminus \{p_0\}$ for some $l \in \mathcal{C}_\Phi$ such that $\text{tc}_\Phi(l) \neq ?$, then $\vec{p} \cdot q$ is a ?-path, for any $q \in (\mathbb{P}_\Phi^{\text{pri}}(l) \cup \mathbb{P}_\Phi^{\text{aux}}(l)) \setminus \{p_n\}$;
- (iv) if $\vec{p} = (p_0, \dots, p_n)$ is a ?-path with $p_n \in \mathbb{P}_\Phi^{\text{aux}}(l) \setminus \{p_0\}$ for some $l \in \mathcal{C}_\Phi^?$, if for any $r \in \mathbb{P}_\Phi^{\text{aux}}(l)$ there is a ?-path from p_0 to r , then $\vec{p} \cdot q$ is a ?-path, for any $q \in (\mathbb{P}_\Phi^{\text{pri}}(l) \cup \mathbb{P}_\Phi^{\text{aux}}(l)) \setminus \{p_n\}$.

For every $p \in \mathcal{P}_\Phi$, the set of the ?-accessible ports from p in Φ is defined as $\text{access}_\Phi^?(p) := \{q \in \mathcal{P}_\Phi \mid \text{there is a ?-path in } \Phi \text{ from } p \text{ to } q\}$.

We require $p_0 \neq p_n$ in rules (iii)-(iv) so that in any ?-path on Φ of the form $p \cdot \vec{r} \cdot p \cdot q$, either $p <_{\frac{1}{\Phi}} q$, or p and q are the two conclusions of a same *ax*-cell (?-paths “start upwards”).

According to Def. 21, given a pps Φ and $p \in \mathcal{P}_\Phi$, the set of ?-accessible ports from p in Φ

- is upward-closed (rule (ii)): if $q \in \text{access}_\Phi^?(p)$ and $q \leq_R q'$ then $q' \in \text{access}_\Phi^?(p)$;
- is “often” downward-closed (rules (iii)-(iv)): if $q \in \text{access}_\Phi^?(p)$ and $q' \notin \text{access}_\Phi^?(p)$ with $q \in \mathbb{P}_\Phi^{\text{aux}}(l)$ and $q' \in \mathbb{P}_\Phi^{\text{pri}}(l)$ for some $l \in \mathcal{C}_\Phi$, then $p \in \mathbb{P}_\Phi^{\text{aux}}(l)$, or $l \in \mathcal{C}_\Phi^?$ and $\mathbb{P}_\Phi^{\text{aux}}(l) \not\subseteq \text{access}_\Phi^?(l)$;
- crosses *ax*-cells and *cut*-cells (rules (ii)-(iii)): if $l \in \mathcal{C}_\Phi^{\text{ax}}$ then either $\mathbb{P}_\Phi^{\text{pri}}(l) \subseteq \text{access}_\Phi^?(p)$ or $\mathbb{P}_\Phi^{\text{pri}}(l) \cap \text{access}_\Phi^?(p) = \emptyset$; if $l \in \mathcal{C}_\Phi^{\text{cut}}$ then either $\mathbb{P}_\Phi^{\text{aux}}(l) \subseteq \text{access}_\Phi^?(p)$ or $\mathbb{P}_\Phi^{\text{aux}}(l) \cap \text{access}_\Phi^?(p) = \emptyset$.

The set $\mathcal{C}_\Phi^{\text{box}}$ and the partial function box_Φ play no role in Def. 21: in other words, ?-paths and ?-accessibility can be equivalently defined in the gs G_Φ of Φ .

Note that ?-accessibility cannot be defined as a binary symmetric relation on the ports of a pps Φ : in general, $q \in \text{access}_\Phi^?(p)$ does not imply that $p \in \text{access}_\Phi^?(q)$, as exemplified by the MELL-ps S in Fig. 8c.

► **Remark 22.** Recalling Remark 6.2, one can easily see that, if Φ and Ψ are pps such that $\varphi: G_\Phi \simeq G_\Psi$, then for every $p \in \mathcal{P}_\Phi$ one has: $\overline{\varphi \mathcal{P}}(\text{access}_\Phi^?(p)) = \text{access}_\Psi^?(\varphi \mathcal{P}(p))$.

We now define the geometric key-notion of box-connectedness: a DiLL-ps is box-connected if, seen as an undirected graph, what is *inside* any box is recursively connected, that is (following [19, 5]), for any two ports p and q on the border of a same box, p and q are connected by a path crossing only ports with depth at least the depth of p (and q). Formally, our definition relies instead on ?-paths, which are a tool used in the proof of Lemma 24.

► **Definition 23** (?-path inside a box, box-connectedness). Given $R \in \mathbf{PS}_{\text{DiLL}}$ and $l \in \mathcal{C}_R^{\text{box}}$, a ?-path $\vec{p} = (p_0, \dots, p_n)$ in R is *inside the box of* l if $p_i \in \text{inbox}_R(l)$ for all $0 \leq i \leq n$.

A DiLL-ps R is *box-connected* if, for any $l \in \mathcal{C}_R^{\text{box}}$ and $p \in \text{inbox}_R(l)$, there is a ?-path in R from $\text{pid}_R(l)$ to p inside the box of l .

For example, the DiLL-ps R_1 and R_2 in Fig. 3b-3c, and R and S in Fig. 7a-7b are box-connected; the DiLL-ps R and S in Fig. 4a and 3a are not box-connected. Clearly, any DiLL₀-ps, or more generally, any DiLL-ps R such that $\text{Doors}_R^? = \emptyset = \text{Doors}_R^{\text{cut}}$, is box-connected.

We stress that the box-connectedness condition (a crucial hypothesis in our main result) is quite general and not *ad hoc*. Indeed, it can be proven that: any ACC⁷ DiLL-ps having neither \perp -cells nor weakenings (*i.e.* ?-cells with no premises) inside boxes is box-connected.

⁷ See [19, Def. A.6, Rmk. A.7] for the definition of ACC for MELL-ps, which can easily be adapted to DiLL-ps: ?-cells (resp. !-cells which are not *box*-cells) are considered as generalized \wp -cells (resp. \otimes -cells).

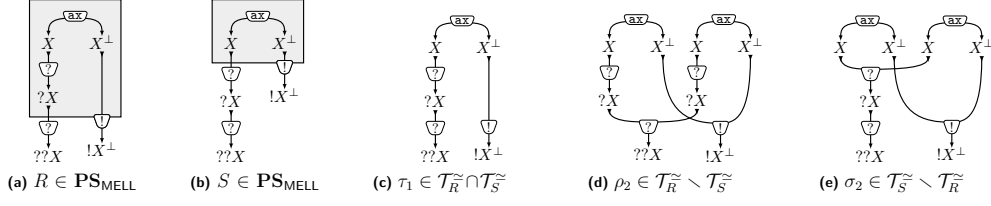

■ **Figure 7** Two non-isomorphic box-connected MELL-ps R (Fig. 7a) and S (Fig. 7b), having in their respective Taylor expansions \mathcal{T}_R^ω and \mathcal{T}_S^ω the same element τ_1 of order 1 (Fig. 7c), but two different elements ρ_2 (Fig. 7d) and σ_2 (Fig. 7e) of order 2, respectively.

In particular, any derivation in MELL sequent calculus without mix-rules, nor \perp -rules nor weakening rules corresponds to a box-connected MELL-ps. Also, any MELL-ps which is the translation of an untyped λ -term (according to the call-by-name type identity $o = !o \multimap o$) is box-connected. Finally, box-connectedness is preserved under cut-elimination.

Box-connection and Taylor expansion Given a box-connected DiLL-ps R and a strongly R -fat $\rho \in \mathcal{T}_R$, all information encoded in the indexes of ports and cells of ρ can be recovered in a “geometric” way via $?$ -accessibility, without looking at the names of ports and cells of ρ : by Lemma 24, in ρ the copy with index a of the content of the box associated with a *box*-cell l of R is exactly the set of $?$ -accessible ports from the premise ($\text{prid}_R(l), a$) of the $!$ -cell (l, a^-) of ρ .

► **Lemma 24** (Geometric characterization of the copies of a box in an element of the labeled Taylor expansion). *Let R be a DiLL-ps, $\rho \in \mathcal{T}_R$ and $(p, a) \in \mathcal{P}_\rho$ with $p = \text{prid}_R(l)$ for some $l \in \mathcal{C}_R^{\text{box}}$.⁸ Let $\mathcal{P}_\rho^{l,a} = \{(q, a \cdot b) \in \mathcal{P}_\rho \mid b \in \mathbb{N}^* \text{ and } q \in \text{inbox}_R(l)\}$. If R is box-connected and ρ is strongly R -fat, then $\mathcal{P}_\rho^{l,a} = \text{access}_\rho^?(p, a)$ and thus $\text{inbox}_R(l) = \overline{\text{forget}_\rho^{\rho, R}(\text{access}_\rho^?(p, a))}$.*

In the proof of Lemma 24, the hypothesis of box-connectedness (resp. strong R -fatness) ensures that the $?$ -accessible ports from $(\text{prid}_R(l), a)$ in ρ contain at least (resp. at most) all the content of the copy with index a of the content of the box associated with the *box*-cell l of R . In Fig. 6, τ is a 2-diffnet of both R and S (so τ is strongly R - and S -fat) but R and S are not box-connected, and indeed (setting $\mathcal{A}_\tau^1 = \text{access}_\tau^?(p, (1))$ and $\overline{\mathcal{A}_\tau^1} = \overline{\text{access}_\tau^?(r, (1))}$):

- in R (Fig. 6a), one has $\text{inbox}_R(l) = \overline{\text{forget}_\tau^{\tau, R}(\mathcal{A}_\tau^1)}$ but $\text{inbox}_R(o) \not\subseteq \overline{\text{forget}_\tau^{\tau, R}(\mathcal{A}_\tau^1)}$;
- in S (Fig. 6b), one has $\text{inbox}_S(o) = \overline{\text{forget}_\tau^{\tau, S}(\mathcal{A}_\tau^1)}$ but $\text{inbox}_R(l) \not\subseteq \overline{\text{forget}_\tau^{\tau, S}(\mathcal{A}_\tau^1)}$.

In Fig. 7, (any representative of) τ_1 (Fig. 7c) is a 1-diffnet of S (hence τ_1 is not strongly S -fat) and the $?$ -accessible ports from the premise of the $!$ -cell of τ_1 cover *more* than the content of the box of *box*-cell of S : only in σ_2 (Fig. 7e), taking two copies of the content of the box, the $?$ -accessible ports correspond exactly to the content of the box.

A consequence of Lemma 24 and Remark 22 in Cor. 25: given two box-connected MELL-ps R and S , and $\rho \in \mathcal{T}_R$ and $\sigma \in \mathcal{T}_S$ strongly fat, any isomorphism φ between ρ and σ “preserves” the copies of the content of a box (Cor. 25.1) and the depth of ports and cells (Cor. 25.2).

► **Corollary 25** (Boxes and copies preservation). *Let $R, S \in \mathbf{PS}_{\text{MELL}}$, $\rho \in \mathcal{T}_R$ and $\sigma \in \mathcal{T}_S$ with $\varphi = (\varphi_{\mathcal{P}}, \varphi_{\mathcal{C}}): \rho \simeq \sigma$. If R and S are box-connected and ρ and σ are strongly fat, then for any $(p, a), (p', a') \in \mathcal{P}_\rho$ and $(q, b), (q', b') \in \mathcal{P}_\sigma$ with $\varphi_{\mathcal{P}}((p, a)) = (q, b)$ and $\varphi_{\mathcal{P}}((p', a')) = (q', b')$:*

1. (copies preserv.) $\text{box}_{\mathcal{P}_R}^{\text{ext}}(p) = \text{box}_{\mathcal{P}_R}^{\text{ext}}(p')$ and $a = a'$ iff $\text{box}_{\mathcal{P}_S}^{\text{ext}}(q) = \text{box}_{\mathcal{P}_S}^{\text{ext}}(q')$ and $b = b'$;
2. (depth preserv.) $\text{depth}_{\mathcal{P}_R}(p) = \text{depth}_{\mathcal{P}_S}(q)$ (and $\text{depth}_{\mathcal{P}_R}(p') = \text{depth}_{\mathcal{P}_S}(q')$).

⁸ This implies that $(l, a^-) \in \mathcal{C}_\rho^!$ and $(p, a) \in \mathbf{P}_\rho^{\text{aux}}((l, a^-))$, according to Def. 11-13.

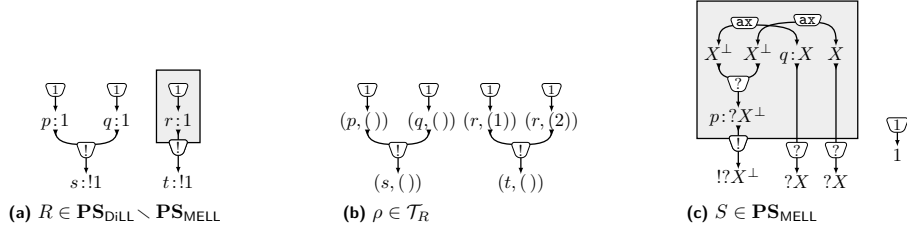

■ **Figure 8** A box-connected DiLL-ps R (Fig. 8a, with $\mathcal{C}_R^{\text{box}} = \{l\}$ and $\mathcal{C}_R \setminus \mathcal{C}_R^{\text{box}} = \{o\}$) and a 2-diffnet ρ (Fig. 8b) of R (see also Remark 26). Moreover, a box-connected MELL-ps S (Fig. 8c).

Cor. 25.2 says that if a port of ρ corresponds to a port of R contained in $n \in \mathbb{N}$ boxes, then its image in σ via φ corresponds to a port of S contained in n boxes, and conversely. Cor. 25.1 means that if two ports of ρ are in the same copy of the content of a box in R , then their images in σ via φ are in the same copy of a box in S , and conversely. The idea of the proof of Cor. 25.1 is that if two ports of ρ are in the same copy of a box in R , then (Lemma 24) they are $?$ -accessible from the same premise of a $!$ -cell of ρ and thus, since $?$ -accessibility is preserved by isomorphism (Remark 22), their images via φ are $?$ -accessible from the same premise of a $!$ -cell of σ , hence (Lemma 24 again) they are in the same copy of a box in S . The proof of Cor. 25.2 is similar. A fact analogous to Cor. 25 holds for cells.

► **Remark 26** (Box-cells preservation). Let $R, S \in \mathbf{PS}_{\text{MELL}}$, $\rho \in \mathcal{T}_R$ and $\sigma \in \mathcal{T}_S$ with $\varphi = (\varphi_{\mathcal{P}}, \varphi_{\mathcal{C}}): \rho \simeq \sigma$. Let $a \in \mathbb{N}^*$ and $l \in \mathcal{C}_R^{\text{box}}$: if $(\text{prid}_R(l), a) \in \mathcal{P}_\rho$ then there are $o \in \mathcal{C}_S^{\text{box}}$ and $b \in \mathbb{N}^*$ such that $\varphi_{\mathcal{P}}((\text{prid}_R(l), a)) = (\text{prid}_S(o), b)$ and $\varphi_{\mathcal{C}}((l, a^-)) = (o, b^-)$, as in a MELL-ps $!$ -cells and *box*-cells coincide. Analogously for every $b \in \mathbb{N}^*$ and $o \in \mathcal{C}_S^{\text{box}}$ with $(\text{prid}_S(o), b) \in \mathcal{P}_\sigma$.

Remark 26 is false in general if R or S is a DiLL-ps: given $R \in \mathbf{PS}_{\text{DiLL}} \setminus \mathbf{PS}_{\text{MELL}}$ and $\rho \in \mathcal{T}_R$ as in Fig. 8a-8b, it is easy to find $\varphi = (\varphi_{\mathcal{P}}, \varphi_{\mathcal{C}}): \rho \simeq \rho$ with $\varphi_{\mathcal{C}}((l, ())) = (o, ())$, *i.e.* φ maps the $!$ -cell of ρ corresponding to the *box*-cell of R into the $!$ -cell of ρ not corresponding to the *box*-cell of R . For this reason Cor. 25 holds only for MELL-ps and not for DiLL-ps, in general.

Cor. 25 (together with Fact 20) is crucial in the proof of the next lemma, which shows how to build an isomorphism ϕ between two box-connected MELL-ps R and S starting from an isomorphism φ between $\rho \in \mathcal{T}_R$ and $\sigma \in \mathcal{T}_S$ strongly fat: roughly speaking, ϕ is just the restriction of φ to only one copy (*e.g.* the first one) in ρ of the content of each box of R .

► **Lemma 27** (Building isomorphism). Let $R, S \in \mathbf{PS}_{\text{MELL}}$, $\rho \in \mathcal{T}_R$ and $\sigma \in \mathcal{T}_S$. Suppose ρ and σ are strongly fat and canonical, and $\varphi = (\varphi_{\mathcal{P}}, \varphi_{\mathcal{C}}): \rho \simeq \sigma$. Let $\phi_{\mathcal{P}}: \mathcal{P}_R \rightarrow \mathcal{P}_S$ and $\phi_{\mathcal{C}}: \mathcal{C}_R \rightarrow \mathcal{C}_S$ be functions defined in Eq. (1). If R and S are box-connected, then $\phi = (\phi_{\mathcal{P}}, \phi_{\mathcal{C}}): R \simeq S$.

$$\begin{aligned} \phi_{\mathcal{P}}(p) &= \text{forget}_{\mathcal{P}}^{\sigma, S}(\varphi_{\mathcal{P}}((p, a))) \quad \text{for every } p \in \mathcal{P}_R \text{ where } (p, a) \in \mathcal{P}_\rho \text{ with } a \in \{1\}^*; \\ \phi_{\mathcal{C}}(l) &= \text{forget}_{\mathcal{C}}^{\sigma, S}(\varphi_{\mathcal{C}}((l, a))) \quad \text{for every } l \in \mathcal{C}_R \text{ where } (l, a) \in \mathcal{C}_\rho \text{ with } a \in \{1\}^*. \end{aligned} \quad (1)$$

► **Theorem 28.** Let R and S be some box-connected MELL-ps. Let $\rho_0 \in \mathcal{T}_R^{\simeq}$ and $\sigma_0 \in \mathcal{T}_S^{\simeq}$ be strongly fat. If $\rho_0 = \sigma_0$ then $R \simeq S$.

Proof. According to Def. 18, $\rho_0 = \sigma_0$ implies that there are $\rho \in \mathcal{T}_R \cap \rho_0$, $\sigma \in \mathcal{T}_S \cap \sigma_0$ and $\varphi = (\varphi_{\mathcal{P}}, \varphi_{\mathcal{C}}): \rho \simeq \sigma$. By Remark 14, we can suppose without loss of generality that ρ and σ are canonical. By hypothesis, ρ and σ are strongly fat. By Lemma 27, there is $\phi: R \simeq S$. ◀

We point out that Thm. 28 holds for any $\rho_0 \in \mathcal{T}_R^{\simeq}$ strongly fat, in particular when ρ_0 is the element of order 2 of the Taylor expansion of R , *i.e.* ρ_0 is obtained from R (up to isomorphism, see Def. 18-19) by taking exactly 2 copies of the content of each box in R . If R or S is not box-connected, or ρ_0 is not strongly fat, then in general $R \not\simeq S$, see Fig. 6-7.

5 Conclusion: injectivity of the relational model

Thm. 28 has a semantic counterpart: the injectivity of relational semantics for box-connected MELL-ps. The *relational model* is the simplest model of MELL; it can be seen as a degenerate case of Girard’s coherent semantics [11], where formulas are interpreted as sets and proofs as relations between them. It is more or less well-known that, given a MELL-ps R , there is a correspondence between certain equivalence classes on its relational interpretation $\llbracket R \rrbracket$ and elements of its Taylor expansion \mathcal{T}_R^\approx (see [12] for a detailed proof): in particular, two cut-free MELL-ps with atomic axioms have the same relational semantics iff they have the same Taylor expansion. Thus, from Thm. 28 it follows that:

► **Corollary 29** (Injectivity for box-connected MELL). *Let R and S be cut-free MELL-ps with atomic axioms and conclusions of the same type.*

1. *If R and S are box-connected, and if $\llbracket R \rrbracket = \llbracket S \rrbracket$, then $R \simeq S$.*
2. *If R and S are sequentializable in MELL sequent calculus without mix-rules, \perp -rules and weakening-rules, and if $\llbracket R \rrbracket = \llbracket S \rrbracket$, then $R \simeq S$.*

Using different techniques, De Carvalho [3] proves the following, more general, theorem:

► **Theorem 30** (De Carvalho [3], injectivity for full MELL). *Let R and S be cut-free MELL-ps with atomic axioms and conclusions of the same type. If $\llbracket R \rrbracket = \llbracket S \rrbracket$, then $R \simeq S$.*

The injectivity proven in [5, Cor. 55] is the same as our Cor. 29.2,⁹ even if the technique used in [5] allows to recover the LPS (see [5, Def. 16-17 and Cor. 52]) of any cut-free MELL-ps R with atomic axioms from its relational semantics $\llbracket R \rrbracket$: this eventually yields a slightly more general injectivity result than our Cor. 29.1.¹⁰ As stressed in §1, our Thm. 28 (and our proof of Cor. 29) differs a lot from the proofs of Thm. 30 and [5, Cor. 52,54-55]: [3, 5] rely on the presence, in the interpretations of MELL-ps, of points with *arbitrarily large* complexity, depending on the two MELL-ps one wishes to discriminate. On the other hand, our result allows to discriminate any two different box-connected, cut-free MELL-ps with atomic axioms using a point of the relational semantics with *fixed* complexity (the order 2).

As a concluding remark, we believe that some kind of “converse” of Thm. 28 holds, which can be stated as follows: if R is a MELL-ps such that the element of order 2 of \mathcal{T}_R^\approx does not belong to \mathcal{T}_S^\approx for any MELL-ps $S \not\approx R$, then R is “connected”. Strictly, such a statement is wrong if we interpret “connected” as box-connected or connected graph in the sense of [5, Cor. 54]. However, we conjecture that a slight modification of these two notions yields a notion of connectedness for which Thm. 28 and its aforementioned converse (so as Cor. 29.1 and [5, Cor. 54]) hold. These results would strengthen the hierarchy outlined in §1.

Acknowledgements Thanks to Daniel de Carvalho for pointing out that our approach to prove the injectivity of the relational semantics is not limited to ACC MELL-ps. Proof-nets are drawn using (a slight modification of) Marc Bagnol’s package `pn.sty`. This work has been partially supported by the French ANR projects ANR-11-IS02-0002 (Locali) and ANR-12-JS02-0006 (CoQuaS), and the French A*MIDEX project ANR-11-IDEX-0001-02.

⁹ Our main results (Thm. 28, Cor. 29) can easily be generalized to untyped MELL-ps, as in [5].

¹⁰ The injectivity proven in [5, Cor. 54] holds for a set of MELL-ps that is “similar” to the one for which our Cor. 29.1 holds: the notion of “connected graph” in [5, Cor. 54] is similar to our box-connectedness, even if, strictly speaking, neither of the two implies the other.

References

- 1 V. Danos and L. Regnier. The structure of multiplicatives. *Archive for Mathematical logic*, 28(3):181–203, 1989.
- 2 V. Danos and L. Regnier. Proof-nets and the Hilbert space. In *Advances in Linear Logic*, pages 307–328. Cambridge University Press, 1995.
- 3 D. de Carvalho. The relational model is injective for Multiplicative Exponential Linear Logic. Preprint available at <http://arxiv.org/abs/1502.02404>, April 2015.
- 4 D. de Carvalho, M. Pagani, and L. Tortora de Falco. A semantic measure of the execution time in Linear Logic. *Theoretical Computer Science*, 412(20):1884–1902, 2011.
- 5 D. de Carvalho and L. Tortora de Falco. The relational model is injective for multiplicative exponential linear logic (without weakening). *Ann. Pure Appl. Logic*, 163(9):1210–1236, 2012.
- 6 T. Ehrhard. Finiteness spaces. *Math. Struct. Comp. Science*, 15(4):615–646, 2005.
- 7 T. Ehrhard and L. Regnier. The differential lambda-calculus. *Theoretical Computer Science*, 309(1-3):1–41, 2003.
- 8 T. Ehrhard and L. Regnier. Differential interaction nets. *Theoretical Computer Science*, 364(2):166–195, 2006.
- 9 T. Ehrhard and L. Regnier. Uniformity and the Taylor expansion of ordinary lambda-terms. *Theoretical Computer Science*, 403(2-3):347–372, 2008.
- 10 H. Friedman. Equality between functionals. In Rohit Parikh, editor, *Logic Colloquium*, volume 453 of *Lecture Notes in Mathematics*, pages 22–37. Springer Berlin, 1975.
- 11 J.-Y. Girard. Linear logic. *Theoretical Computer Science*, 50(1):1–102, 1987.
- 12 G. Guerrieri, L. Pellissier, and L. Tortora de Falco. Syntax, Taylor expansion and relational semantics of MELL proof-structures: an unusual approach. Technical report, 2016. Available at <http://logica.uniroma3.it/~tortora/mell.pdf>.
- 13 Y. Lafont. From Proof-Nets to Interaction Nets. In *Advances in Linear Logic*, pages 225–247. Cambridge University Press, 1995.
- 14 O. Laurent. Polarized proof-nets and $\lambda\mu$ -calculus. *Theor. Comp. Sci.*, 290(1):161–188, 2003.
- 15 D. Mazza and M. Pagani. The Separation Theorem for Differential Interaction Nets. In *Proceedings of LPAR 2007*, pages 393–407, 2007.
- 16 M. Pagani. The Cut-Elimination Theorem for Differential Nets with Boxes. In *Proceedings of TLCA 2009*, pages 219–233, 2009.
- 17 M. Pagani and C. Tasson. The Taylor Expansion Inverse Problem in Linear Logic. In *Proceedings of LICS 2009*, pages 222–231, 2009.
- 18 R. Statman. Completeness, invariance and λ -definability. *J. Symb. Logic*, 47(1):17–26, 1982.
- 19 L. Tortora de Falco. Obsessional Experiments For Linear Logic Proof-Nets. *Mathematical Structures in Computer Science*, 13(6):799–855, December 2003.
- 20 P. Tranquilli. Intuitionistic differential nets and lambda-calculus. *Theoretical Computer Science*, 412(20):1979–1997, 2011.